

Non-Dimmable Plug-in Adapter









AL-97-01-12006, AL-97-01-24006



Non-Dimmable Plug-In Adapters provide portable, easy-to-install power for LED lighting, both for temporary installations and permanent ones where a driver cannot be installed. They featured DC plugs that connect directly to the Polara LED Puck Light and DC plug accessories. These adapters are already derated, which means they can be loaded to maximum wattage capacity.

- IP40 for use indoors in dry environments
- 2 year warranty

QUICK SPECIFICATIONS

Input		120V AC
Features	  	100% maximum load 0% minimum load Class 2
Environment	 	Dry environment (IP40) Protected against solid objects greater than 1mm
Certifications	 	RoHS UL Listed
Warranty		2 year limited

DIMENSIONS

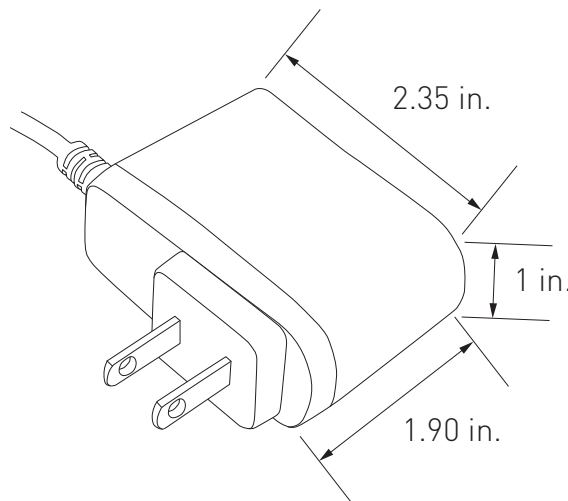

TECHNICAL INFORMATION

Item #		AL-97-01-12006	AL-97-01-24006
Output	Voltage	12V DC	24V DC
	Load Current	0.5A	0.25A
	Rated power	6W	6W
	Hold-up Time	10mS	10mS
	Ripple	200mV	200mV
Input	Voltage Range	120V AC	
	Frequency Range	50/60Hz	
	AC Inrush Current	Typical input voltage and output at full load, 25°C / 77°F	
	Efficiency	Typical input voltage & output at full load	
Protection	Short Circuit	The adapter will not damage by short the DC output to ground	
	Over Current	Auto Recovery	
Environment	Operating Temp.	30°C (±10°C), 86°F (±18°F), normal input voltage	
	Working Humidity	5~90%RH, non-condensing	
	Storage Temp., Humidity	-20~+85°C, -4~185°F / 5~95%RH	
Safety	Safety Standards	UL Listed	
Reliability	High Potential Test	Gradually raised from 0 to the 3000V AC and held at that value for 3s,10mA	
	Burn-in	At 30°C (±10°C), 86°F (±18°F), normal input voltage, 2~4 hours	
Other	Warranty	2 Year Limited	
	DC Cable Length	4.9 ft.	
	Weight	Approx. 3 oz.	
	Size	2.35 x 1 x 1.9 in.	

IP (INGRESS PROTECTION) RATING GUIDE

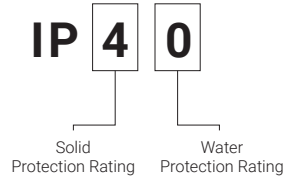

Solid Ingress Rating

Water Ingress Rating

0 Not protected against solid objects

0 Not protected against water

1 Protected against solid objects greater than 50mm

1 Protected against vertically falling water droplets

2 Protected against solid objects greater than 12.5mm

2 Protected against vertically falling water droplets with enclosure titled up to 15°

3 Protected against solid objects greater than 2.5mm

3 Protected against sprays of water up to 60°

4 Protected against solid objects greater than 1mm

4 Protected against water splashes from all directions

5 Protected against limited amounts dust

5 Protected against jets of water

6 Dust tight

6 Protected against heavy seas and jets of water

7 Protected against immersion in 1m of water for up to 30 min.