

4-in-1 PowerFactor™ Dimmable Driver with Junction Box

AL-98-10-24200-4in1













4-in-1 PowerFactor™ Dimmable Drivers provide smooth, stable, efficient, and flicker-free dimming capability for LED lighting. They are compatible with many models of:

- MLV (forward phase dimming)
- ELV (reverse phase dimming)
- 0-10V dimming
- 1-10V dimming

This sophisticated power supply is rated for dry, damp and wet location use.

QUICK SPECIFICATIONS

Input		100~277 volts AC
Features	  	99% PowerFactor 100% maximum load 10% minimum load
Environment	 	Dry/damp/wet environment
Certifications	  	UL Listed RoHS NEMA 4X
Warranty		6 year limited

DIMENSIONS

Junction Box Dimensions

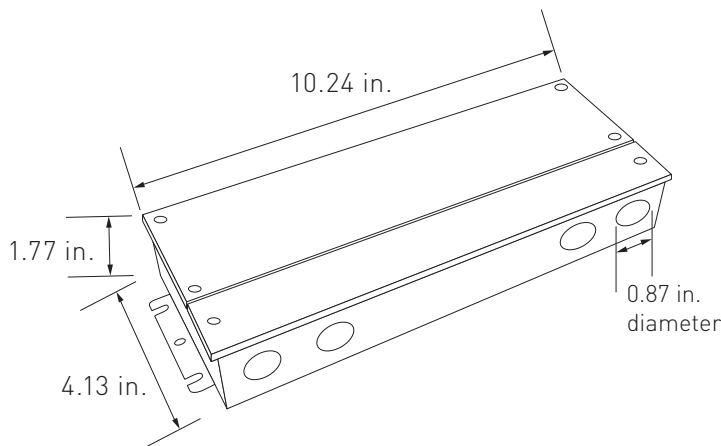

TECHNICAL INFORMATION

Item Number		AL-98-10-24200-4in1
Output	DC Voltage	24V DC
	Rated Current	8.33A
	Rated Power	200W
	Voltage Tolerance	±0.5V
	Voltage Regulation	±0.5%
	Load Regulation	±1%
Input	Voltage Range	100-277V AC
	Frequency Range	47~63Hz
	Power Factor (Typ.) at Full Load	0.98@120V AC, 0.95@277V AC
	THD (Typ.) at Full Load	<20%
	Efficiency (Typ.) at Full Load	86% @120V AC, 88%@277V AC
	AC Current (Maximum)	2.3A@100V AC
	Inrush Current (Typ.)	15A, 50%, 1.4ms @120V AC; 30A, 50%, 1.4ms @277V AC
Leakage Current	<0.50mA	
Protection	Short Circuit	Shut down o/p voltage, re-power on to recover after fault condition is removed
	Over Loading	≤120% shut down o/p voltage, re-power on to recover after fault condition is removed
	Over Temperature	100°C±10°C / 212°F±50°F shut down o/p voltage, automatically recover after cooling
Environment	Working Temperature / Humidity	-40~+60°C / -40~+140°F / 20~90%RH, non-condensing
	Storage Temperature Humidity	-40~+80°C / -40~+176°F / 10~95%RH
	Temperature Coefficient	±0.03%/°C (0~50°C) / (32~122°F)
	Vibration	10~500Hz, 5G 10min. / 1 cycle, period for 60min. each along X,Y,Z axes
Safety and EMC	Safety Standards	UL8750
	Withstand Voltage	I/P-O/P:1.88KV AC
	Isolation Resistance	I/P-O/P:100MΩ / 500V DC / 25°C / 70%RH
	EMC Emission	FCC 47 CFR Part 15, Subpart B
Other	Warranty	6 Year Limited
	Size (Junction Box) LxWxH	10.24 x 4.13 x 1.77 in. (LxWxH)

All parameters if NOT specially mentioned are measured at 120V AC input, rated load and 25°C/77°F ambient temperature.

Warning: Do NOT reverse polarity high voltage input of the driver as it will destroy the product.

WIRING DIAGRAMS

Using a Standard Wall Dimmer

TRIAC dimming

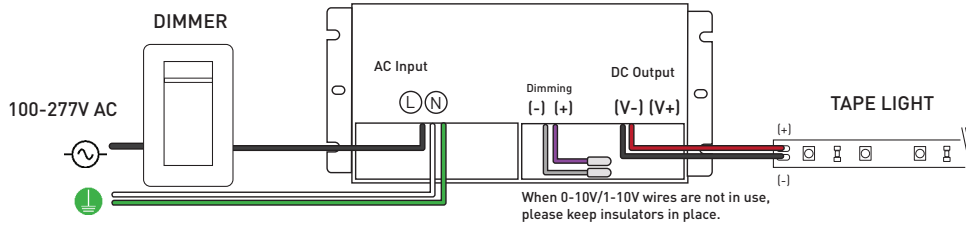

0-10V/1-10V dimming

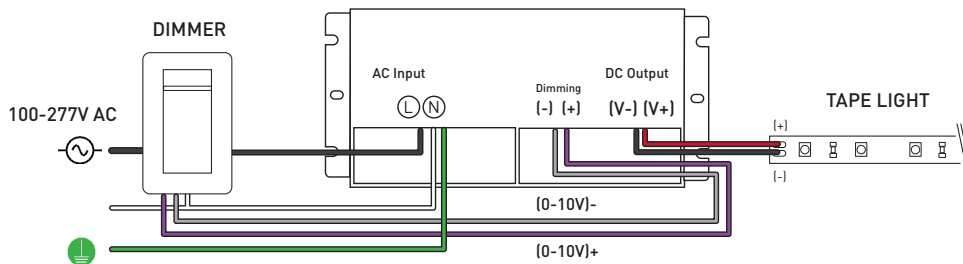

Note: Dimmer switch wiring for reference use only. Please follow wiring instructions provided with the dimmer switch.

SAFETY & TIPS

- Before commencing any installation or maintenance work, disconnect the driver from AC power entirely.
- Maintain 4-6 inches clearance around the driver and make sure that it is exposed to open airflow. Do not mount the driver near a heat source.
- Installing this driver in a high ambient temperature environment may increase the internal component temperature and will require a derating in output current.
- The current rating of the high-voltage supply wire should be greater than that of the driver's current requirement.
- When using wet location models of this driver to power LED lighting with wet location connectors, verify that the connection between the driver and the lighting fixture is watertight.

TROUBLESHOOTING

Q: Why are the lights connected to the driver blinking roughly once a second?

A: The driver may be overloaded. Check to make sure the maximum wattage is not being exceeded. There could also be a possibility of incompatible voltage. Confirm that the driver and tape light voltage match.

Q: How do I determine the compatibility?

A: Check the voltage, wattage, load capacity of both the tape light and driver.

Q: Is it possible to have multiple runs of tape light that are daisy-chained together connect to a driver with 1 lead wire?

A: Yes, but only if the total length of consecutive runs do not exceed the tape light's maximum run and also does not exceed the driver's maximum wattage.