

# PowerFactor™ Dimmable LED Driver with Junction Box











AL-98-10-24300



PowerFactor Dimmable Drivers provide smooth, stable, and efficient dimming capability for LED lighting. They are compatible with many models of Triac, ELV, MLV, forward and reverse phase dimmers, and on/off switches. All PowerFactor multi-tap models, and wattages up to 24V/96W, are Class 2 compliant, making them safe and inspection-ready.

- High power factor for high efficiency
- Dry/damp/wet environment
- Flicker-free 100~0% dimming

## QUICK SPECIFICATIONS

|                       |   |   |
|-----------------------|---|---|
| <b>Input</b>          |    | 120~277V AC   |
| <b>Features</b>       |          | 99% Power Factor<br>100% maximum load<br>10% minimum load |
| <b>Environment</b>    |     | Dry/damp/wet environment                                  |
| <b>Certifications</b> |    | UL Listed<br>NEMA 4X<br>RoHS                              |
| <b>Warranty</b>       |    | 6 year limited  |

## DIMENSIONS

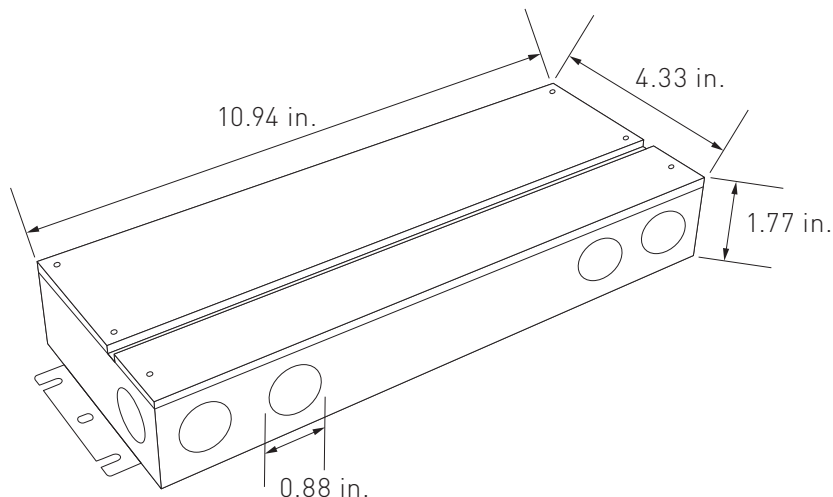

## TECHNICAL INFORMATION

| Item Number           |                               | AL-98-10-24300  |
|-----------------------|-------------------------------|---|
| <b>Output</b>         | DC Voltage                    | 24V DC  |
|                       | Voltage Regulation            | ±0.5V   |
|                       | Rated Current                 | 12.5A   |
|                       | Rated Power                   | 300W  |
|                       | Load Regulation               | ± 1%  |
| <b>Input</b>          | Voltage Range                 | 120~277V AC   |
|                       | Frequency Range               | 47~63HZ   |
|                       | Power Factor (Avg.)           | ≥0.99 (120V AC) ; ≥0.97 (277V AC)                                       |
|                       | Full Load Efficiency (Avg.)   | >88%  |
|                       | AC Current (Maximum)          | 3.4A (110V AC)  |
|                       | Inrush Current                | 20A, 50%, 1.9ms   |
|                       | Leakage Current               | <0.5mA  |
| <b>Protection</b>     | Short Circuit                 | Short circuit protection: re-powers on after fault condition is removed |
|                       | Overloading                   | ≤120% shut down o/p voltage, re-power on to recover                     |
| <b>Environment</b>    | Working Temperature           | -40~+60°C / -40~+140°F  |
|                       | Working Humidity              | 20~90% RH, non-condensing   |
|                       | Storage Temperature, Humidity | -40~+80°C, -40~176°F / 10~95% RH  |
| <b>Safety and EMC</b> | Safety Standards              | UL 8750   |
|                       | Withstand Voltage             | I/P-O/P: 1.88KV AC  |
|                       | Isolation Resistance          | I/P-O/P: 100MΩ/500V DC/25°C, 77°F/70% RH                                |
|                       | EMC Emission                  | FCC 47 CFR Part 15, Subpart B   |
| <b>Other</b>          | Warranty                      | 6 year limited  |
|                       | Dimensions (L x W x H)        | 10.94 x 4.33 x 1.77 in.   |
|                       | Knockouts (Number - dia.)     | 8 knockouts - 7/8 in.   |

## WIRING DIAGRAMS

---

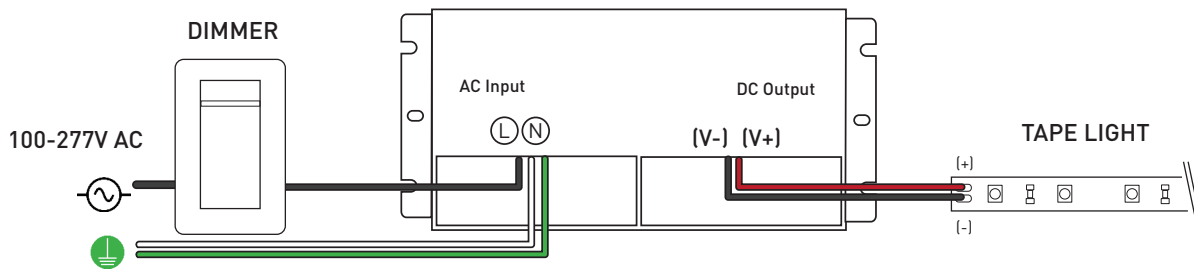

## TROUBLESHOOTING

---

Q: Why are the lights connected to the driver blinking roughly once a second?

A: The driver may be overloaded. Check to make sure the maximum wattage is not being exceeded. There could also be a possibility of incompatible voltage. Confirm that the driver and tape light voltage match.

Q: How do I determine the compatibility?

A: Check the voltage, wattage, load capacity of both the tape light and driver.

Q: Is it possible to have multiple runs of tape light that are daisy-chained together connect to a driver with 1 lead wire?

A: Yes, but only if the total length of consecutive runs do not exceed the tape light's maximum run and also does not exceed the driver's maximum wattage.