

## Non-Dimmable Plug-in Adapter









AL-97-01-12036, AL-97-01-24036



Non-Dimmable Plug-In Adapters provide portable, easy-to-install power for LED lighting, both for temporary installations and permanent ones where a driver cannot be installed. They featured DC plugs that connect directly to the Polara LED Puck Light and DC plug accessories. These adapters are already derated, which means they can be loaded to maximum wattage capacity.

- IP40 for use indoors in dry environments
- 2 year warranty

### QUICK SPECIFICATIONS

Input		120V AC
Features	  	100% maximum load 0% minimum load Class 2
Environment	 	Dry environment (IP40) Protected against solid objects greater than 1mm
Certifications	 	RoHS UL Recognized Component
Warranty		2 year limited

### DIMENSIONS

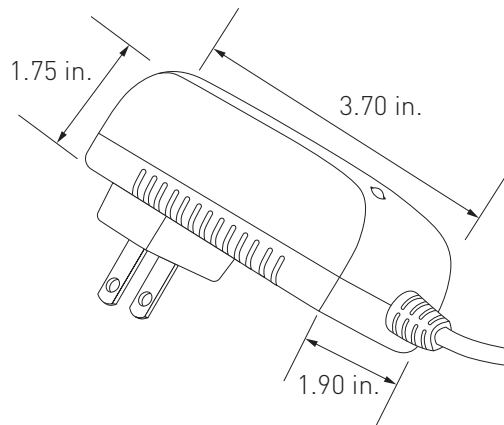

## TECHNICAL INFORMATION

Item #		AL-97-01-12036	AL-97-01-24036
<b>Output</b>	Voltage	12V DC	24V DC
	Load Current	3A	1.5A
	Rated power	36W	36W
	Hold-up Time	10mS	10mS
	Ripple	200mV	200mV
<b>Input</b>	Voltage Range	120V AC	
	Frequency Range	50/60Hz	
	AC Inrush Current	Typical input voltage and output at full load, 25°C / 77°F	
	Efficiency	Typical input voltage & output at full load	
<b>Protection</b>	Short Circuit	The adapter will not damage by short the DC output to ground	
	Over Current	Auto Recovery	
<b>Environment</b>	Operating Temp.	0°~40°, 32°F-104°	
	Working Humidity	5~90%RH, non-condensing	
	Storage Temp., Humidity	-20~+85°C, -4~185°F / 5~95%RH	
<b>Safety</b>	Safety Standards	UL Listed	
<b>Reliability</b>	High Potential Test	Gradually raised from 0 to the 3000V AC and held at that value for 3s,10mA	
	Burn-in	At 30°C (±10°C), 86°F (±18°F), normal input voltage, 2~4 hours	
<b>Other</b>	Warranty	2 Year Limited	
	DC Cable Length	4.92 ft.	
	Weight	Approx. 6 oz.	
	Size	3.7 x 1.9 x 1.75 in.	

IP (INGRESS PROTECTION) RATING GUIDE

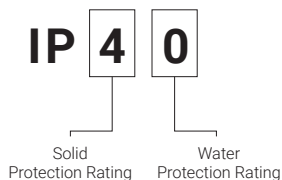

**Solid Ingress Rating**

**Water Ingress Rating**

<b>0</b>	Not protected against solid objects
<b>1</b>	Protected against solid objects greater than 50mm
<b>2</b>	Protected against solid objects greater than 12.5mm
<b>3</b>	Protected against solid objects greater than 2.5mm
<b>4</b>	Protected against solid objects greater than 1mm
<b>5</b>	Protected against limited amounts dust
<b>6</b>	Dust tight

<b>0</b>	Not protected against water
<b>1</b>	Protected against vertically falling water droplets
<b>2</b>	Protected against vertically falling water droplets with enclosure titled up to 15°
<b>3</b>	Protected against sprays of water up to 60°
<b>4</b>	Protected against water splashes from all directions
<b>5</b>	Protected against jets of water
<b>6</b>	Protected against heavy seas and jets of water
<b>7</b>	Protected against immersion in 1m of water for up to 30 min.