

Non-Dimmable Plug-in Adapter









AL-97-01-12060, AL-97-01-24060



Non-Dimmable Plug-In Adapters provide portable, easy-to-install power for LED lighting, both for temporary installations and permanent ones where a driver cannot be installed. They featured DC plugs that connect directly to the Polara LED Puck Light and DC plug accessories. These adapters are already derated, which means they can be loaded to maximum wattage capacity.

- IP40 for use indoors in dry environments
- 2 year warranty

QUICK SPECIFICATIONS

| | | |
|-----------------------|---|--|
| Input |  | 120V AC |
| Features |    | 100% maximum load 0% minimum load Class 2 |
| Environment |   | Dry environment (IP40) Protected against solid objects greater than 1mm |
| Certifications |   | RoHS UL Recognized Component |
| Warranty |  | 2 year limited |

DIMENSIONS

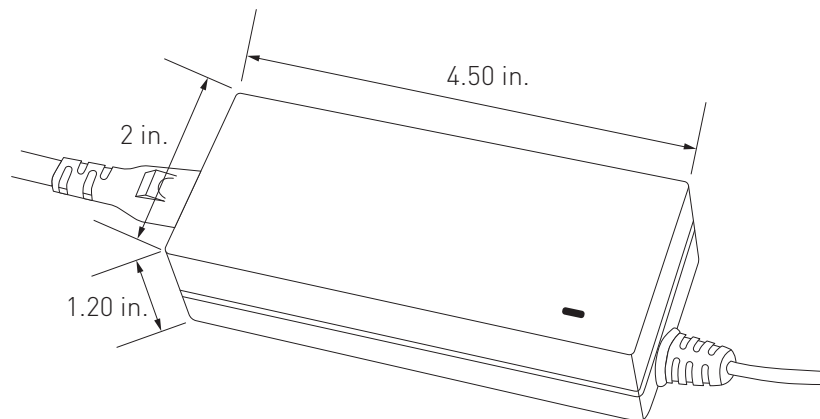

TECHNICAL INFORMATION

| Item # | | AL-97-01-12060 | AL-97-01-24060 |
|--------------------|-------------------------|--|----------------|
| Output | Voltage | 12V DC | 24V DC |
| | Load Current | 5A | 2.5A |
| | Rated power | 60W | 60W |
| | Hold-up Time | 10mS | 10mS |
| | Ripple | 200mV | 200mV |
| Input | Voltage Range | 120V AC | |
| | Frequency Range | 50/60Hz | |
| | AC Inrush Current | Typical input voltage and output at full load, 25°C / 77°F | |
| | Efficiency | Typical input voltage & output at full load | |
| Protection | Short Circuit | The adapter will not damage by short the DC output to ground | |
| | Over Current | Auto Recovery | |
| Environment | Operating Temp. | 0°~40°, 32°F-104° | |
| | Working Humidity | 5~90%RH, non-condensing | |
| | Storage Temp., Humidity | -20~+85°C, -4~185°F / 5~95%RH | |
| Safety | Safety Standards | UL Listed | |
| Reliability | High Potential Test | Gradually raised from 0 to the 3000V AC and held at that value for 3s,10mA | |
| | Burn-in | At 30°C (±10°C), 86°F (±18°F), normal input voltage, 2~4 hours | |
| Other | Warranty | 2 Year Limited | |
| | DC Cable Length | 4.92 ft. | |
| | Weight | Approx. 8 oz. | |
| | Size | 4.5 x 2 x 1.2 in. | |

IP (INGRESS PROTECTION) RATING GUIDE

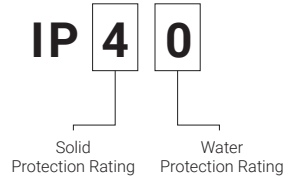

Solid Ingress Rating

Water Ingress Rating

0 Not protected against solid objects

0 Not protected against water

1 Protected against solid objects greater than 50mm

1 Protected against vertically falling water droplets

2 Protected against solid objects greater than 12.5mm

2 Protected against vertically falling water droplets with enclosure titled up to 15°

3 Protected against solid objects greater than 2.5mm

3 Protected against sprays of water up to 60°

4 Protected against solid objects greater than 1mm

4 Protected against water splashes from all directions

5 Protected against limited amounts dust

5 Protected against jets of water

6 Dust tight

6 Protected against heavy seas and jets of water

7 Protected against immersion in 1m of water for up to 30 min.