

ALLOY LED[®] Specifications

0-10V Dimmable Drivers with Junction Box









AL-98-06-24060-277



0-10V dimmable LED drivers are designed to integrate into existing 0-10V dimming systems and provide smooth, efficient power and dimming capability for LED lighting. These drivers include an inspection-ready UL Listed junction box enclosure and offer unparalleled performance for 0-10V systems. These drivers are already derated, which means they can be loaded to maximum wattage capacity.

- Includes UL Listed junction Box
- 100% to 1% dimming
- For use indoors in dry/damp environments
- No minimum load
- 5 year warranty

QUICK SPECIFICATIONS

Input		100-277V AC
Features	  	100% maximum load 0% minimum load Class 2
Environment	 	Dry/damp environment
Certifications	 	UL Listed RoHS
Warranty		5 year limited

DIMENSIONS

Junction Box Dimensions

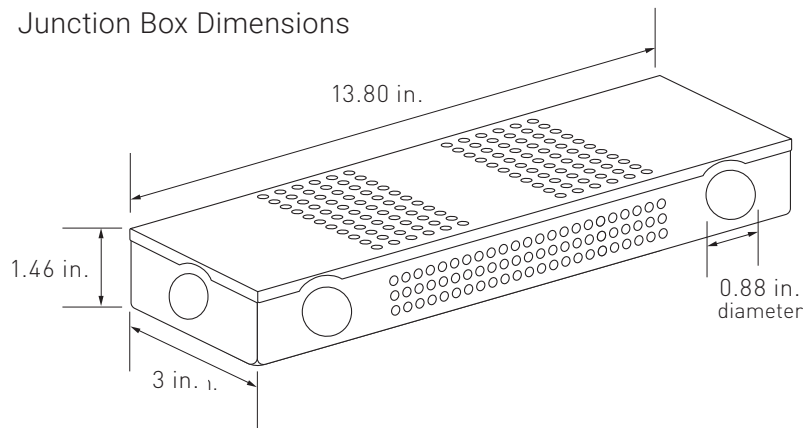

ALLOY LED[®] Specifications

TECHNICAL INFORMATION

Item #	AL-98-06-24060-277	
Output	DC Voltage	24V DC
	Rated Current	2.5A
	Rated Power	60W
	Voltage Accuracy	±0.5V
	Dimming Range	100~1%
Input	Voltage Range	100~277V AC
	Frequency Range	47~63HZ
	Power Factor (Avg.)	0.98 @ 120V AC 0.95 @ 277V AC
	Full Load Efficiency (Avg.)	83% @ 120V AC 84% @ 277V AC
	AC Current (Max.)	0.9A
	Inrush Current	14A, 50%, 780us @ 120V AC 15A, 50%, 660us @ 277V AC
	Leakage Current	<0.5mA
Protection	Short Circuit	Shut down o/p voltage, re-power on to recover after fault condition removed
	Over Temperature	100°C ± 10° C (212°F ± 50°F)- Shut down o/p voltage, automatic recovery after cooling
	Over Voltage	≤120% Hiccup mode, recovers automatically after fault condition is removed
Environment	Working Temp.	-40 ~ +60°C, -40 ~ +140°F
	Working Humidity	20~95% RH, non-condensing
	Storage Temp., Humidity	-40 ~ +80°C, -40~176°F / 10~95%RH
	Temp Coefficient	±0.03%/°C (0~50°C, 32~122°F)
	Vibration	10~500Hz, 2G 10min./1 cycle, period for 60 min. each along X, Y, Z axes
Safety & EMC	Safety Standards	UL8750+UL1310, CAN/CSA-C22.2 No.250.13
	Withstand Voltage	I/P-O/P: 1.88KV AC
	Isolation Resistance	I/P-O/P:>100MΩ/500V DC/25°C, 77°F/70% RH
	EMC Emission	FCC 47 CFR Part 15, Subpart B
Other	Warranty	5 Year Limited
	Dimensions (L x W x H)	13.8 x 3 x 1.46 in.
	Knockouts (# - dia.)	6 knockouts - 7/8 in.

All parameters NOT specially mentioned are measured at 110V / 220V AC input, rated load, and 25°C, 77°F of ambient temperature.

Warning: Do NOT reverse polarity high voltage input of the driver as it will destroy the product.

WIRING DIAGRAMS

Using a Standard Wall Dimmer

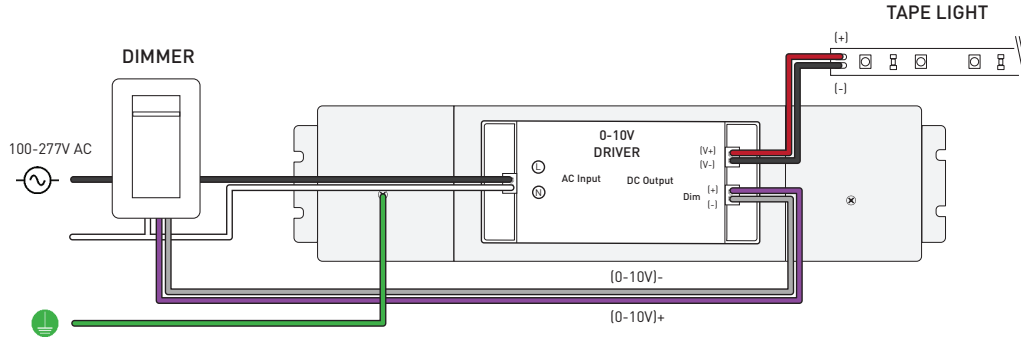

Note: Dimmer switch wiring for reference use only. Please follow wiring instructions provided with the dimmer switch.

TROUBLESHOOTING

Q: Why are the lights connected to the driver blinking roughly once a second?

A: The driver may be overloaded. Check to make sure the maximum wattage is not being exceeded. There could also be a possibility of incompatible voltage. Confirm that the driver and tape light voltage match.

Q: How do I determine the compatibility?

A: Check the voltage, wattage, load capacity of both the tape light and driver.

Q: Is it possible to have multiple runs of tape light that are daisy-chained together connect to a driver with 1 lead wire?

A: Yes, but only if the total length of consecutive runs do not exceed the tape light's maximum run and also does not exceed the driver's maximum wattage.

ALLOY LED[®] Specifications

0-10V Dimmable Drivers with Junction Box









AL-98-06-24080-277



0-10V dimmable LED drivers are designed to integrate into existing 0-10V dimming systems and provide smooth, efficient power and dimming capability for LED lighting. These drivers include an inspection-ready UL Listed junction box enclosure and offer unparalleled performance for 0-10V systems. These drivers are already derated, which means they can be loaded to maximum wattage capacity.

- Includes UL Listed junction box
- 100% to 1% dimming
- For use indoors in dry/damp environments
- 100~277V AC input for commercial and residential
- No minimum load
- 5 year warranty

QUICK SPECIFICATIONS

Input		100-277V AC
Features	  	100% maximum load 0% minimum load Class 2
Environment	 	Dry/damp environment
Certifications	 	UL Listed RoHS
Warranty		5 year limited

DIMENSIONS

Junction Box Dimensions

